

WoodBee

Handleiding • NL

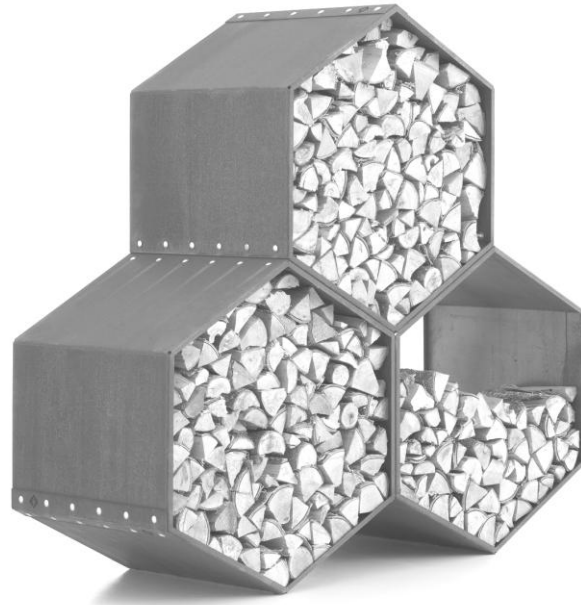

De WoodBee dient door twee personen opgebouwd te worden.

Veiligheidsvoorschriften

- Deze instructie altijd bewaren.
- De onderdelen kunnen scherpe randen bevatten; **gebruik veiligheidshandschoenen** tijdens het opbouwen.
- Draai alle bouten en moeren goed vast voor een stevige constructie.
- Verzekert u zich ervan dat de WoodBee op een vlakke en solide ondergrond is geplaatst.
- De WoodBee is uitsluitend geschikt voor opslag van stookhout en is nadrukkelijk geen speelgoed of klimtoestel. Zorg ervoor dat het niet als zodanig wordt gebruikt; dit kan een gevaarlijke situatie veroorzaken.
- Opmerking: dit product is vervaardigd uit CorTen-staal, dit metaal geeft na verloop van tijd een egale roesthuid aan het product. Deze roesthuid vertraagt het verdere roestproces.

Meegeleverde onderdelen voor 1 module

- 3x schaaldeel
- 3x verbindingsstrip
- 36x slotbout M8, met sluitring en moer (meestal 1 extra set meegeleverd)

Benodigd gereedschap (niet bijgeleverd)

- Steek- of ringsleutel 13mm
- Eventueel; flinke schroevendraaier als hulp voor positioneren gaten

1 module

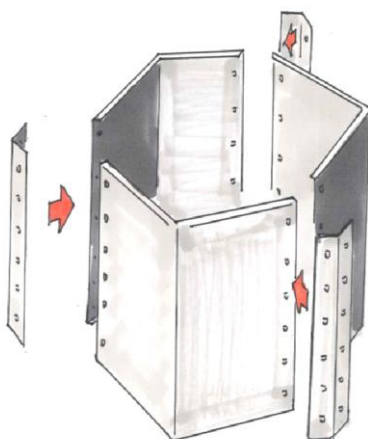

3 modules

1-4

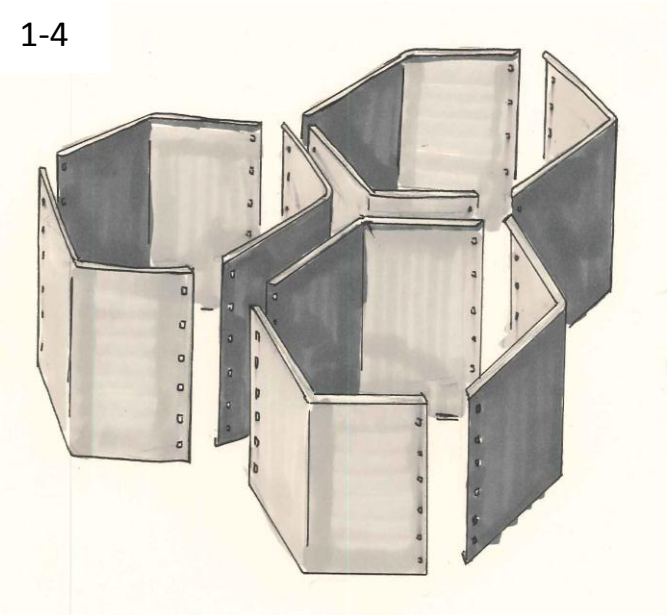

2-4

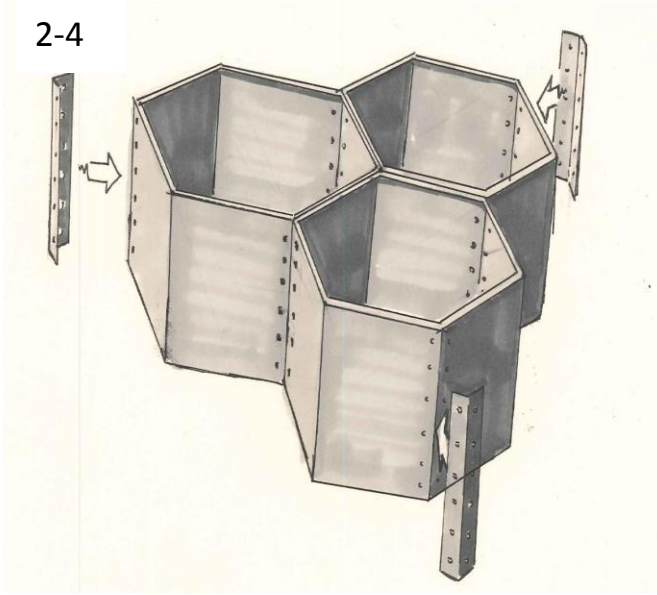

3-4

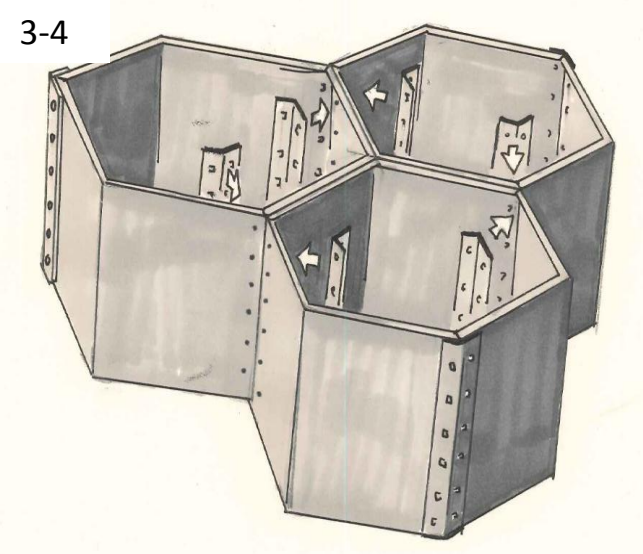

4-4

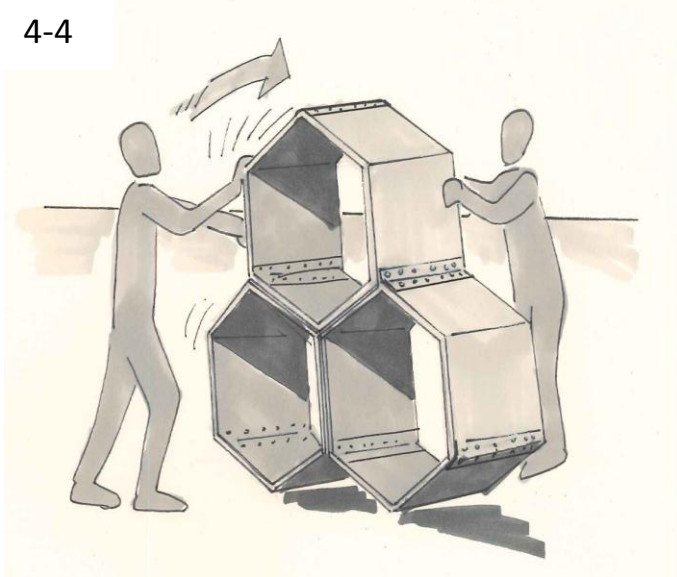

3 modules +

Let op: voor het plaatsen van de uitbreiding van de WoodBee is het noodzakelijk om de houtvoorraad uit te laden. Dit maakt de bouten en moeren bereikbaar.

1-8

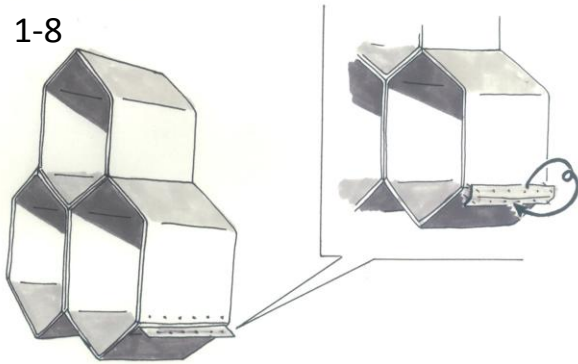

2-8

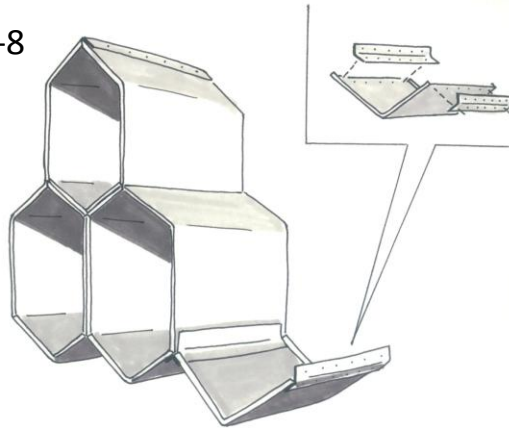

3-8



4-8

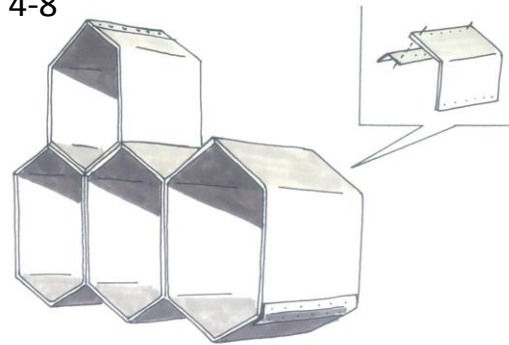

5-8

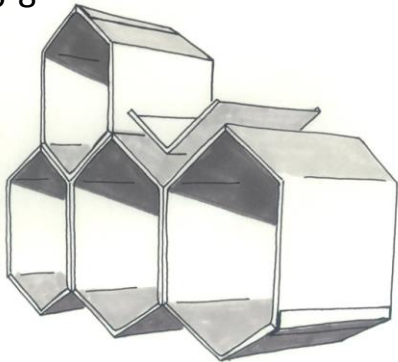

6-8

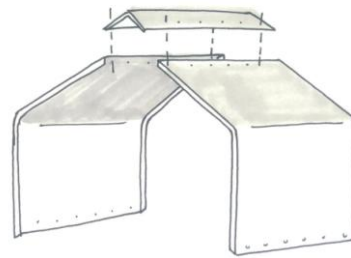

7-8

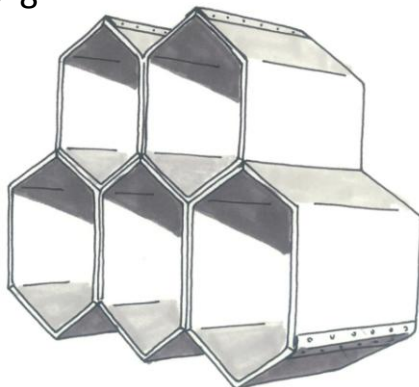

8-8

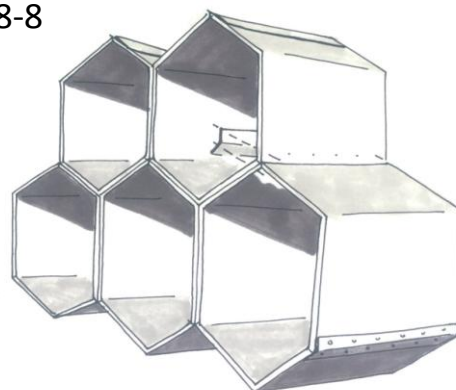

WoodBee

Manual • UK

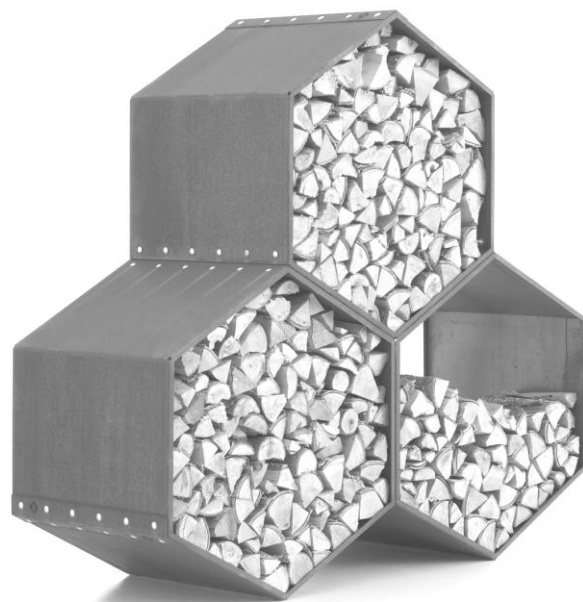

The WoodBee is to be assembled by two persons.

Safety instructions

- Make sure to keep these instructions.
- The parts may have sharp edges; **use protective gloves** when assembling the WoodBee.
- Tighten all bolts and nuts firmly to ensure a sturdy construction.
- Make sure the WoodBee is placed on a flat and solid surface.
- The WoodBee has been designed exclusively for storing stove wood and is definitely not a plaything or climbing frame. Ensure that it is not used that way since this may cause a highly dangerous situation.
- Note: this product is made of CorTen steel. This metal imparts with the passage of time a uniform, thin rust film to the product. This rust film effectively retards the rusting process.

Parts supplied with delivery of 1 module

- 3x cell part
- 3x connecting strip
- 36x mushroom head bolt M8, with washer and nut (delivery usually includes 1 additional set)

Tools required (not included)

- Open-end spanner or ring spanner 13mm

Possibly, a large screwdriver which can be helpful in positioning the holes

1 module

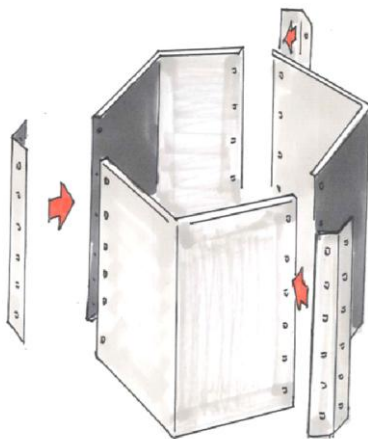

3 modules

1-4

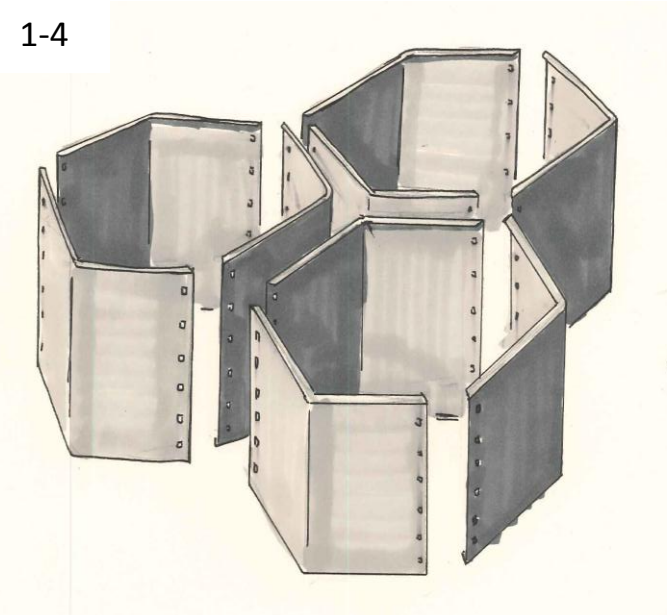

2-4

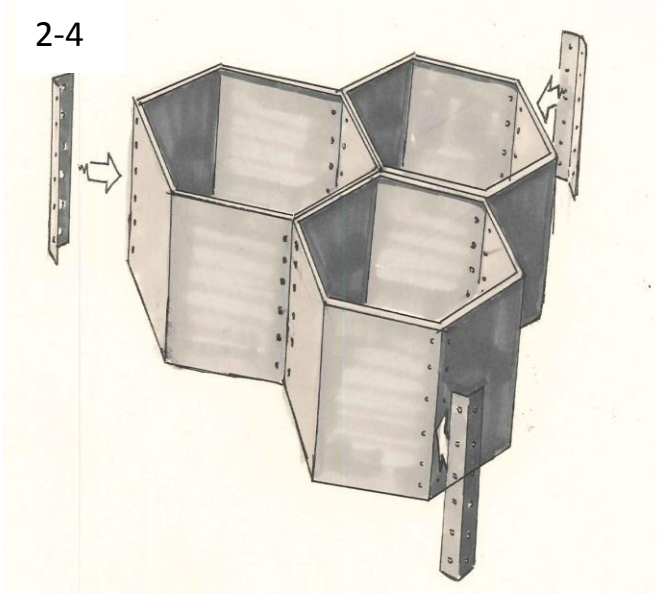

3-4

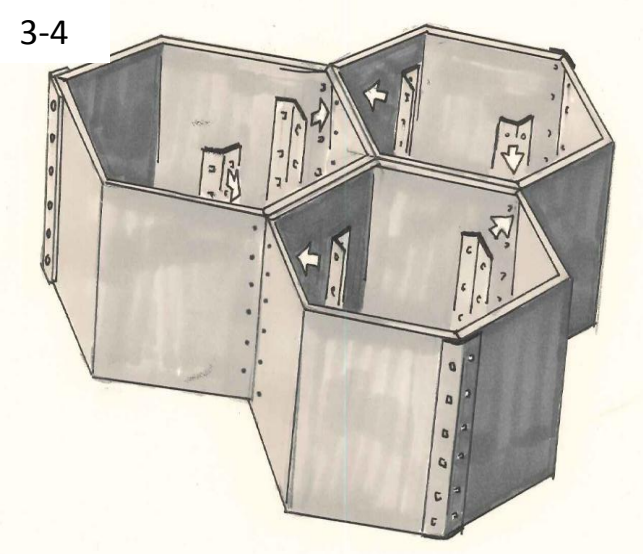

4-4

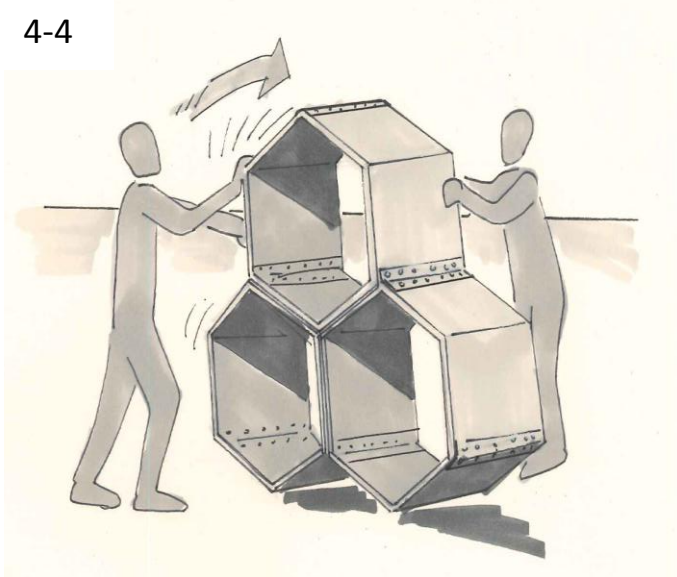

3 modules +

Caution: when adding the extension to the WoodBee, it will be necessary to unload the supply of wood in order to make the nuts and bolts accessible.

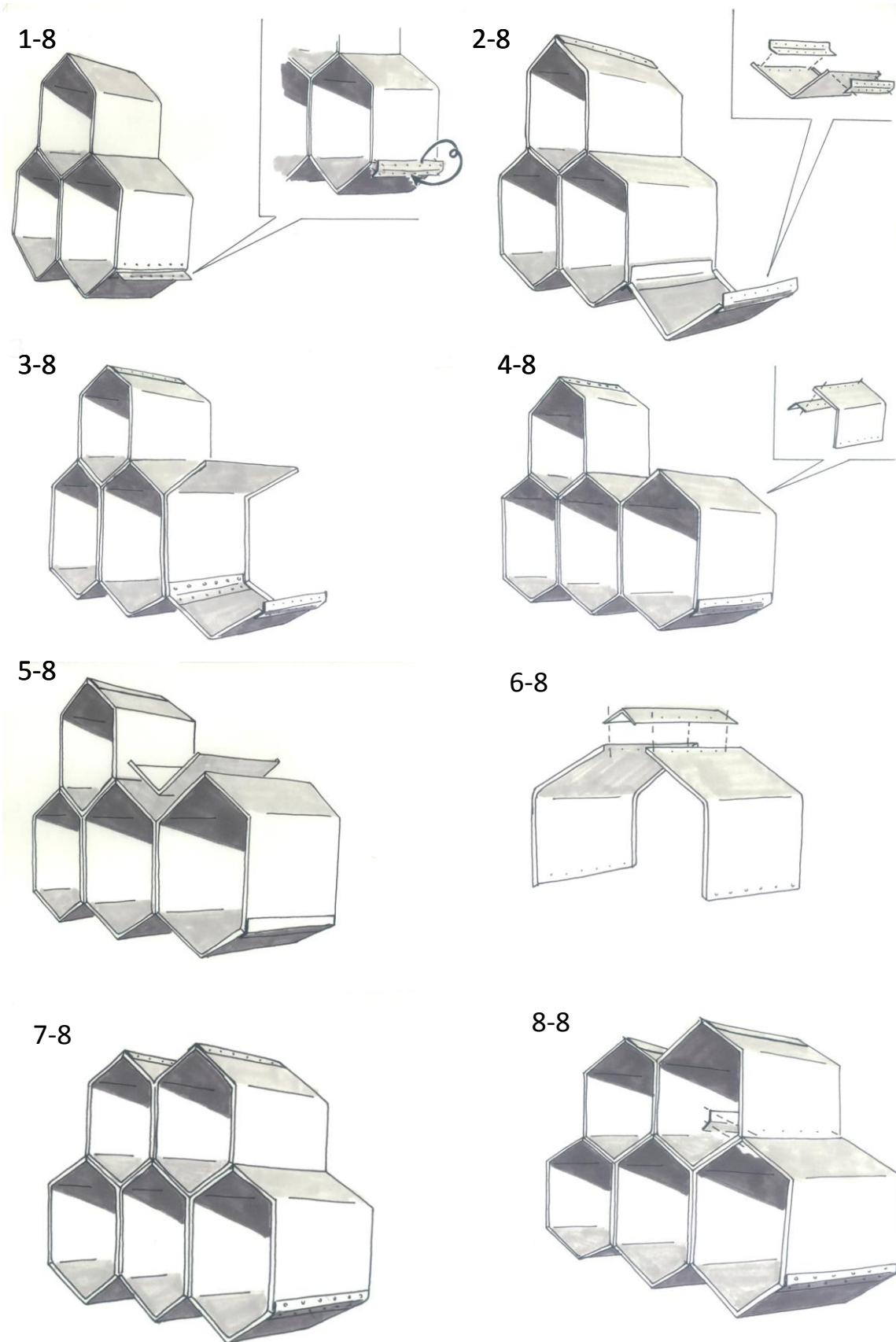

WoodBee

Manuel • F

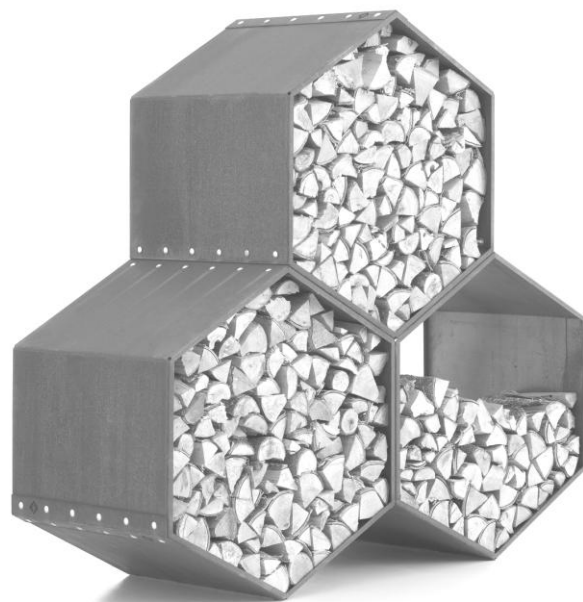

Le WoodBee doit être monté par deux personnes.

Consignes de sécurité

- Toujours conserver ces instructions.
- Les composants peuvent présenter des arêtes tranchantes ; **utilisez toujours des gants de protection** pendant le montage.
- Serrez fermement tous les boulons et écrous pour une construction solide.
- Assurez-vous que le WoodBee est placé sur un sol plat et solide.
- Le WoodBee convient uniquement au stockage de bois de chauffage et n'est en aucun cas un jouet ou un jeu à grimper. Veillez à ce qu'il ne soit pas utilisé comme tel ; cela peut entraîner une situation dangereuse.
- Remarque : ce produit est réalisé en acier CorTen. Sur cet acier se forme au cours du temps une pellicule de rouille. Cette pellicule de rouille ralentit le processus de corrosion.

Composants inclus pour 1 module

- 3x coin
- 3x bande de fixation
- 36x boulon M8, avec rondelle et écrou (généralement 1 jeu supplémentaire inclus)

Outillage requis (non inclus)

- Clé plate ou polygonale 13 mm
- Éventuellement gros tournevis pour faciliter le positionnement des trous

1 module

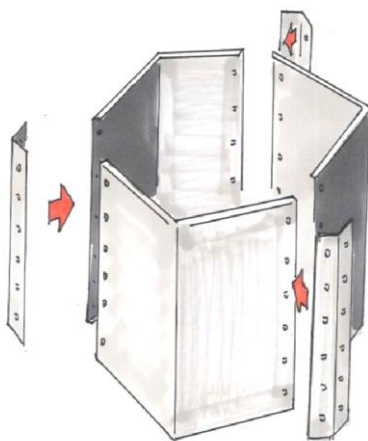

3 modules

1-4

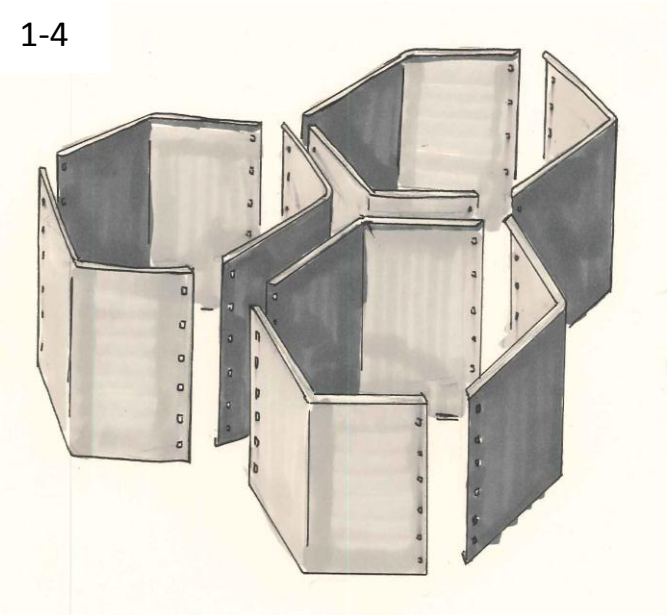

2-4

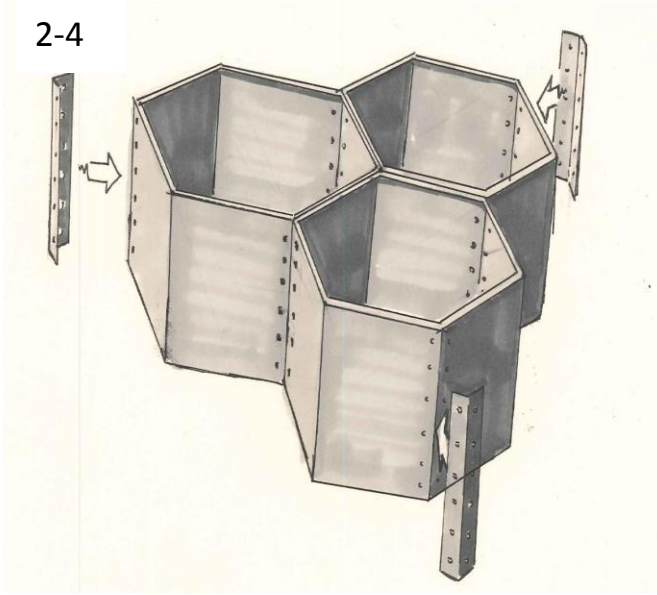

3-4

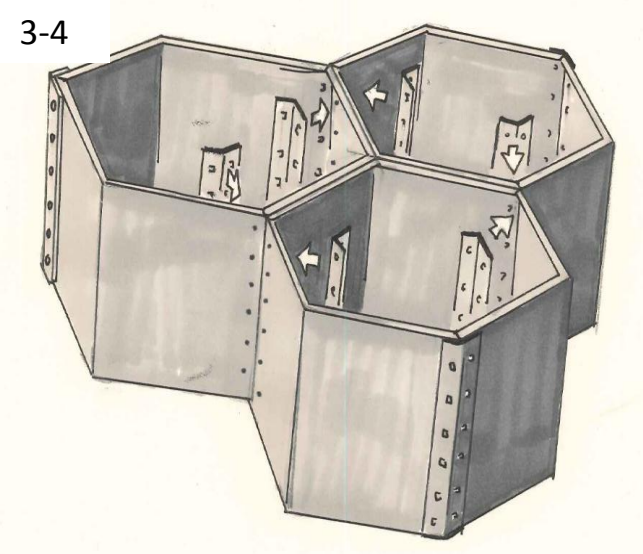

4-4

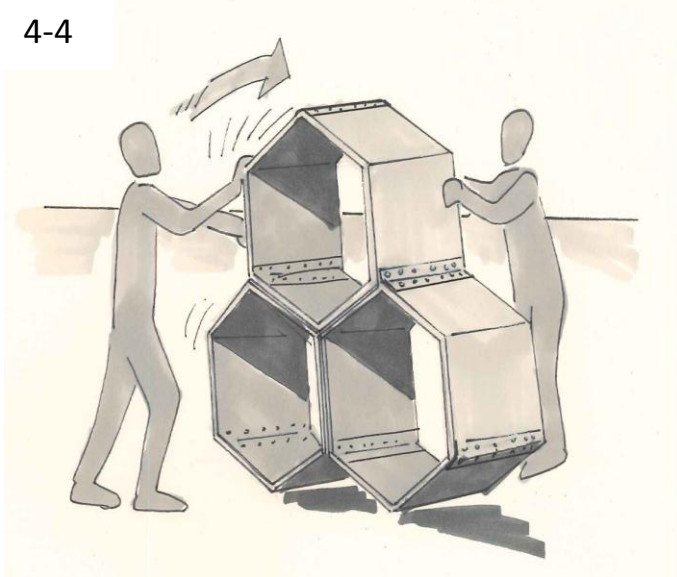

3 modules +

Attention : avant le placement de l'extension du WoodBee, le bois stocké doit être retiré. Ceci permet d'accéder aux boulons et aux écrous.

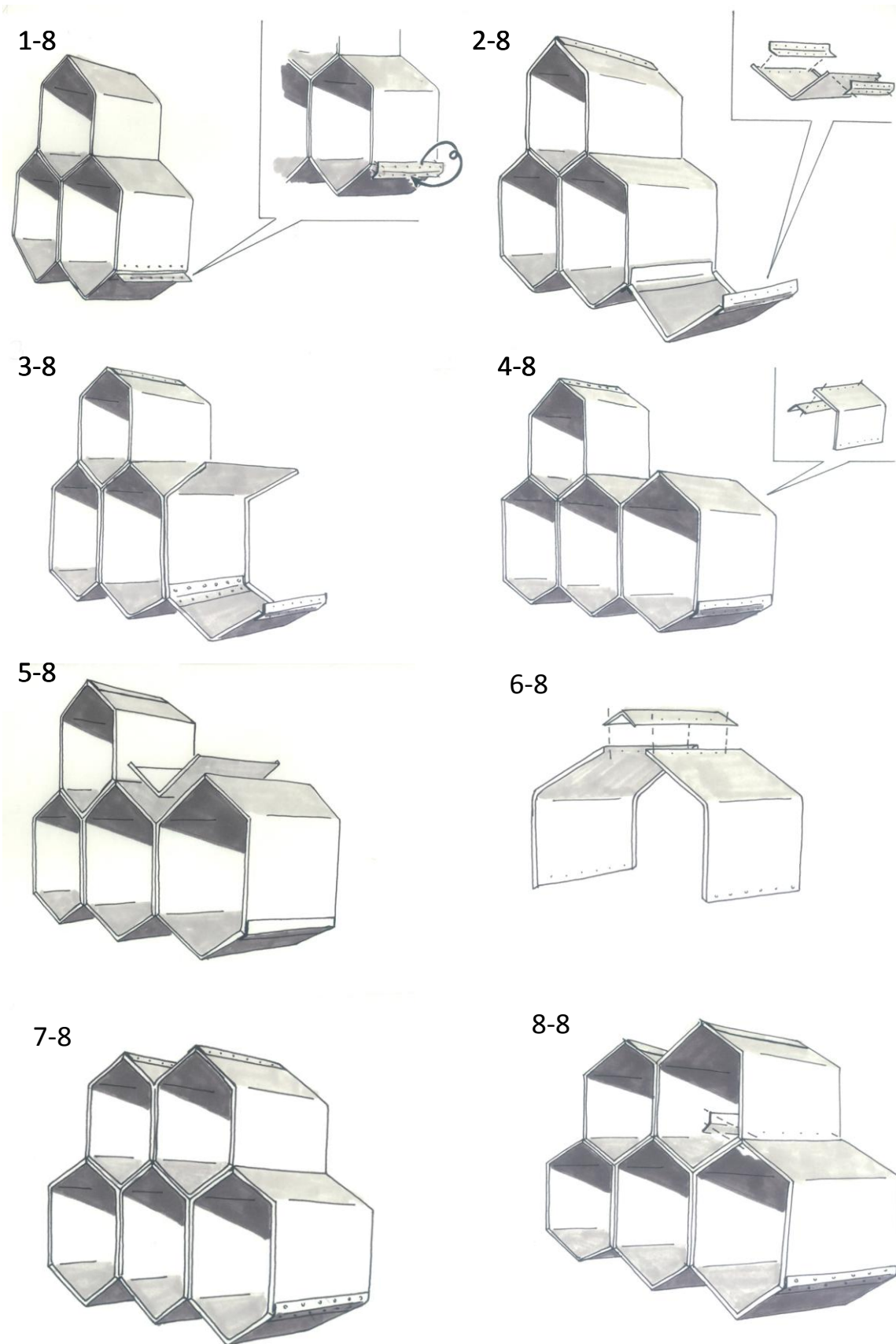

WoodBee

Anleitung • D

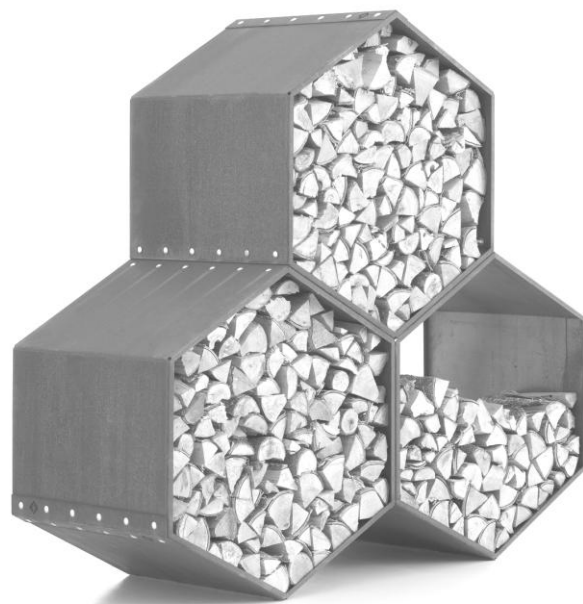

Der WoodBee muss von zwei Personen aufgebaut werden.

Sicherheitsvorschriften

- Diese Anweisung stets aufbewahren.
- Die Bauteile können scharfe Ränder aufweisen; während des Aufbaus **Sicherheitshandschuhe tragen**.
- Alle Schrauben und Muttern gut anziehen, um eine stabile Konstruktion zu erreichen.
- Vergewissern Sie sich, dass der WoodBee auf einem ebenen und soliden Untergrund aufgestellt ist.
- Der WoodBee ist ausschließlich zum Lagern von Brennholz geeignet. Ausdrücklich: Er ist kein Spielzeug und kein Klettergerät. Sorgen Sie dafür, dass er nicht als Spielzeug oder Klettergerät benutzt wird; dadurch kann sich eine gefährliche Situation ergeben.
- Bemerkung: Dieses Produkt ist hergestellt aus CorTen-Stahl; dieses Metall verleiht dem Produkt nach gewisser Zeit eine gleichmäßige Rostschicht. Diese Rostschicht verzögert den weiteren Rostprozess.

Mitgelieferte Bauteile für 1 Modul

- 3 x Schalenteil;
- 3 x Verbindungsstreifen;
- 36 x Schloßschraube M8, mit Unterlegscheibe und Mutter (meistens 1 zusätzlicher Satz mitgeliefert).

Benötigtes Werkzeug (nicht mitgeliefert)

- Steck- oder Ringschlüssel 13 mm;
- Eventuell: handlicher Schraubendreher als Hilfe zum Positionieren der Löcher.

1 Modul

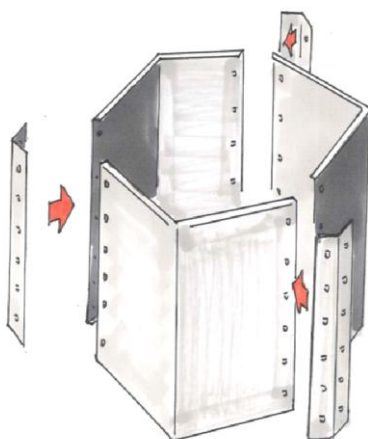

3 Module

1-4

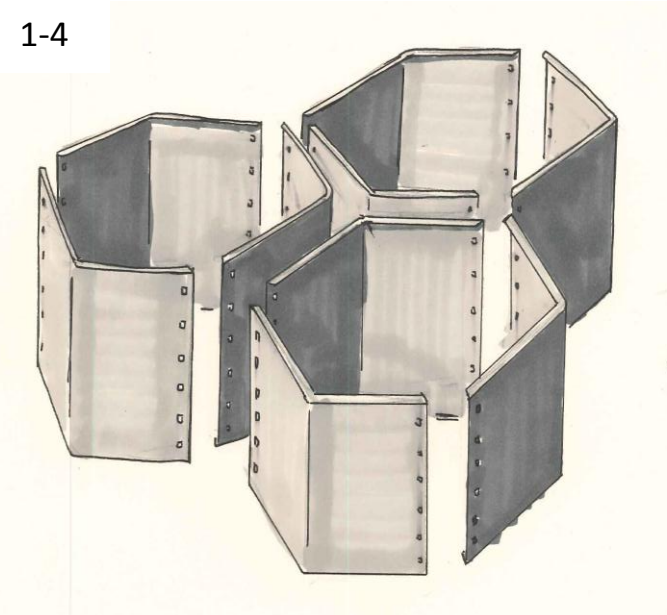

2-4

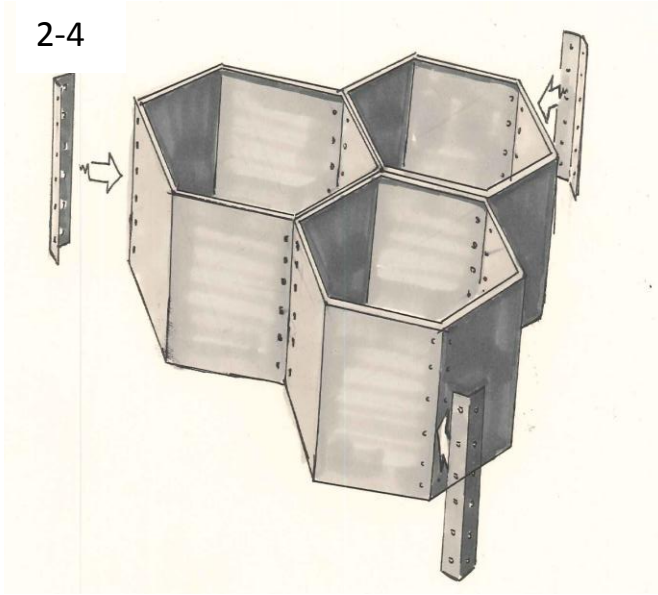

3-4

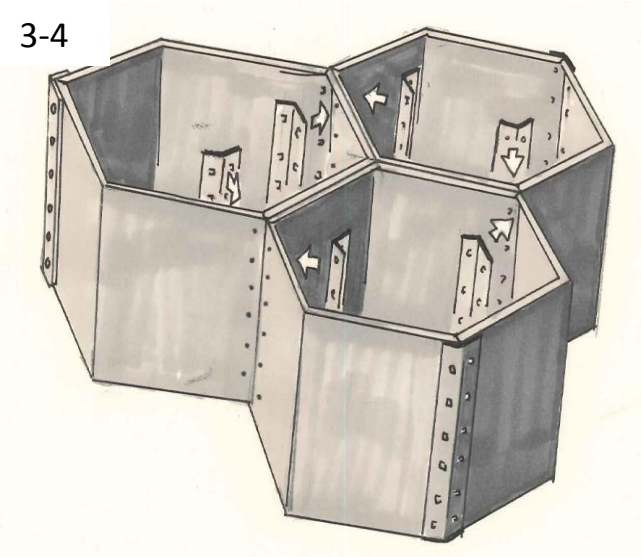

4-4

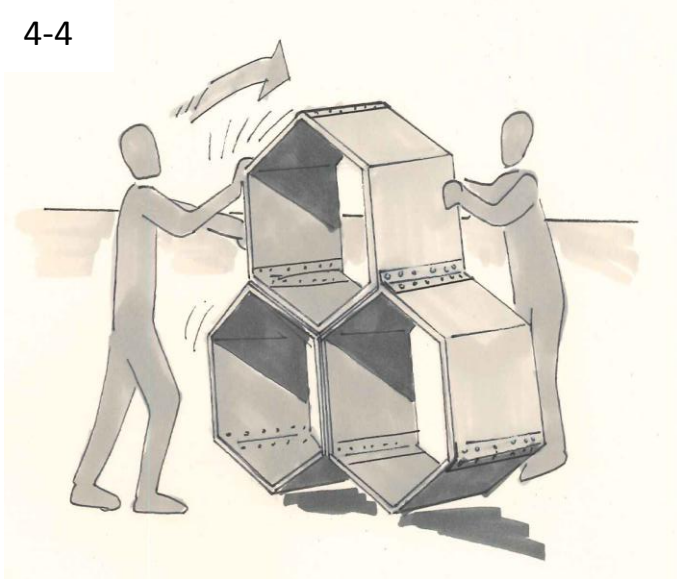

3 Module +

Achtung: Zur Anbringung der Erweiterung des WoodBee ist es notwendig, den Holzvorrat herauszunehmen. Dadurch sind die Schrauben und Muttern erreichbar.

1-8

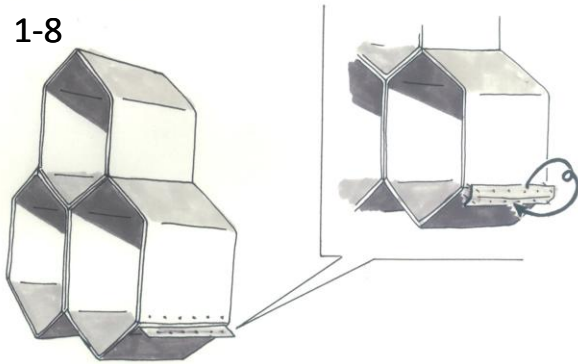

2-8

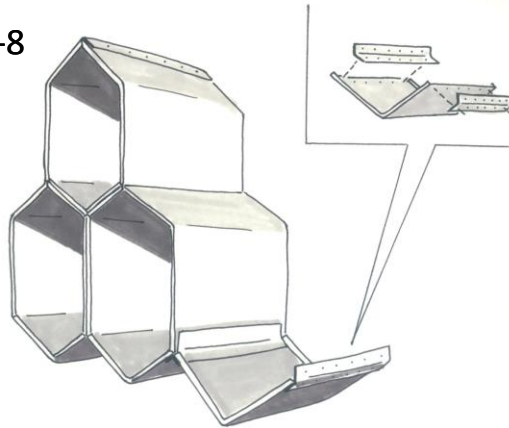

3-8



4-8

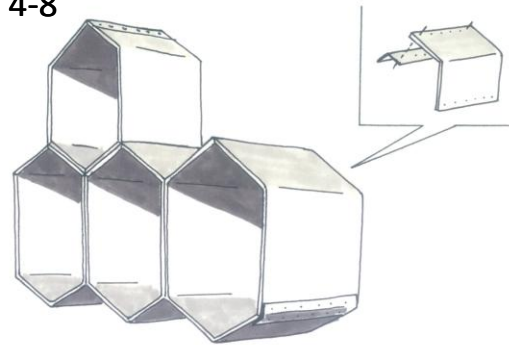

5-8



6-8

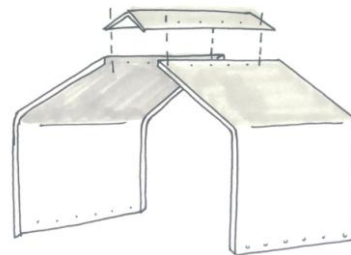

7-8

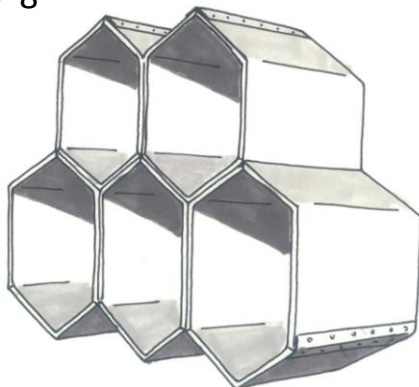

8-8

